

INSTRUCTION MANUAL

CC SERIES

POWER SUPPLY

CONSTANT CURRENT POWER SUPPLY

KEPCO INC.
An ISO 9001 Company.

 MODEL CC SERIES POWER SUPPLY	
ORDER NO.	REV. NO.

NOTE: This on-line version of the Technical Manual includes only installation and operating instructions. For the complete manual, please contact Kepco.

©2000, KEPCO, INC.



KEPCO®

THE POWER SUPPLIER™

KEPCO, INC. 1 131-38 SANFORD AVENUE 1 FLUSHING, NY. 11352 U.S.A. 1 TEL (718) 461-7000 1 FAX (718) 767-1102
email: hq@kepcopower.com 1 World Wide Web: <http://www.kepcopower.com>

TABLE OF CONTENTS

PARAGRAPH		PAGE
SECTION I – INTRODUCTION		
1-1	Scope of Manual	1-1
1-3	General Description	1-1
1-9	Accessories	1-1
1-11	Specifications, General	1-2
1-12	Specifications, Performance	1-2
1-13	Specifications, Physical	1-3
SECTION II – INSTALLATION		
2-1	Unpacking and Inspection	2-1
2-3	Terminations	2-1
2-4	A-C Power Requirements	2-1
2-7	A-C Grounding	2-2
2-9	D-C (Signal) Grounding and Isolation	2-3/2-4
2-11	Preliminary Check-Out Procedure	2-3/2-4
2-13	Installation	2-3/2-4
2-15	Cooling	2-3/2-4
SECTION III – OPERATION		
3-1	Operating Considerations	3-1
3-5	Standard Operation, Local Control	3-2
3-10	Introduction to Remote Programming	3-3
3-15	Adjustments for Precision Programming Ratio	3-4
3-18	Remote Resistance Programming	3-4
3-23	Remote Programming by a Control Voltage	3-5
3-30	Extension of the Power Supply Range	3-8
SECTION IV – THEORY OF OPERATION		
4-1	General	4-1
4-3	Simplified Diagram Discussion	4-1
4-6	Detailed Circuit Description	4-2
SECTION V – MAINTENANCE		
5-1	General	5-1
5-3	Disassembly	5-1
5-5	Internal Adjustments	5-2
5-7	A-C Stability Adjustment	5-2
5-11	Overcurrent Adjustment	5-2
5-14	Trouble Shooting	5-2
5-17	Performance Measurements	5-3
5-19	D-C Measurements	5-3
SECTION VI – PARTS LIST AND DIAGRAMS		
6-1	General	6-1/6-2
6-3	Ordering Information	6-1/6-2

LIST OF ILLUSTRATIONS

FIGURE		PAGE
1-1	Kepeco CC Current Stabilizer Typical (Uncased) Module	-iii-
1-2	Accessories, Kepeco Plug-in Modules	-iv-
1-3	Mechanical Outline Drawing, CC Design Group	1-4
2-1	Conversion to 230V A-C Source Operation and Location of Internal Adjustments	2-1
2-2	Rear Terminations, CC Group	2-2
2-3	Terminations and Controls, Front Panel	2-2
3-1	Comparison, Voltage vs. Current Stabilizer	3-1
3-2	Rear Connections for Standard Operation	3-2
3-3	The Current Stabilizer Model	3-3
3-4	Programming Ratio Adjustment (Standard)	3-4
3-5	Resistance Programming	3-5
3-6	Remote Output Current Control by Voltage	3-6
3-7	Sine Wave Programming, (Waveforms)	3-6
3-8	Connections for Sine Wave Programming	3-7
3-9	Connections for D-C Voltage Programming	3-8
3-10	Automatic Parallel Connection	3-9
3-11	Master/Slave Parallel Connection	3-9
3-12	Simplified Connection Diagram, CC Module	3-10/3-11
4-1	Simplified Diagram	4-1
5-1	Disassembly	5-1
5-2	Test Set-Up for Output Effect Measurements	5-4
6-1	Chassis Component Location	6-9/6-10
6-2	PCB #1 (A1) Component Location	6-11/6-12
6-3	Main Schematic	6-13/6-14

LIST OF TABLES

TABLE		PAGE
1-1	D-C Output and A-C Input, CC Group	1-2
1-2	Output Effects	1-3
2-1	Internal Controls	2-1
2-2	Terminations and Controls, Front Panel	2-2
3-1	Load Ranges, CC Group	3-1

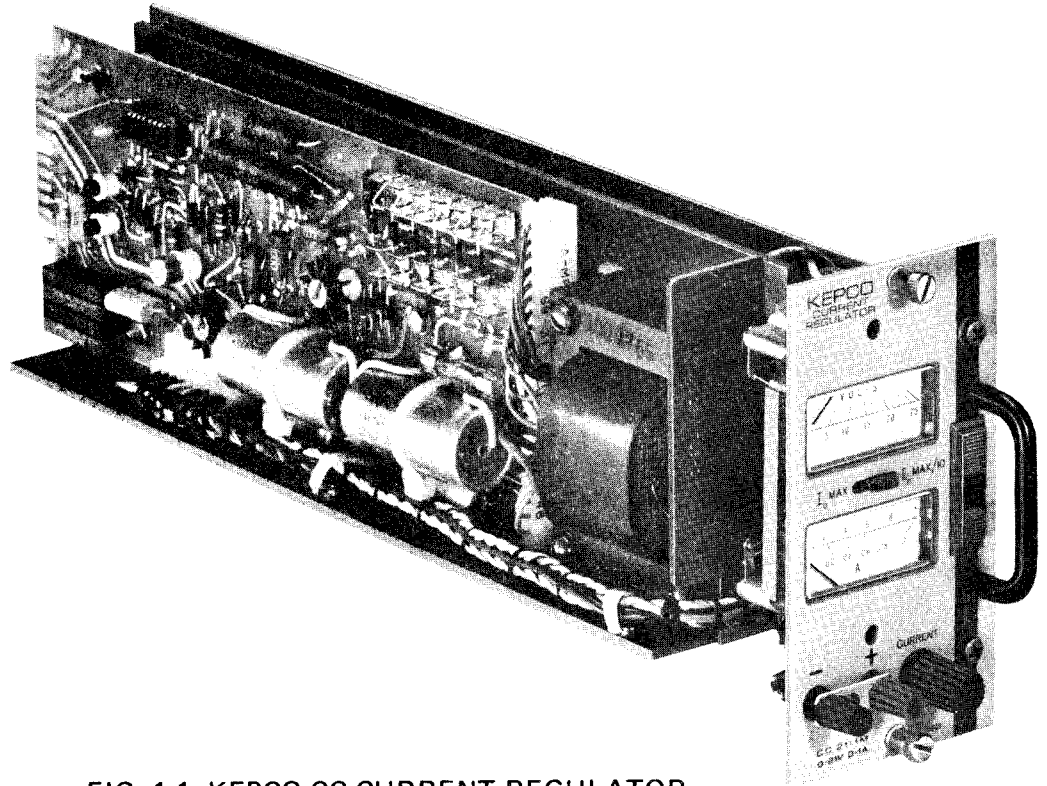
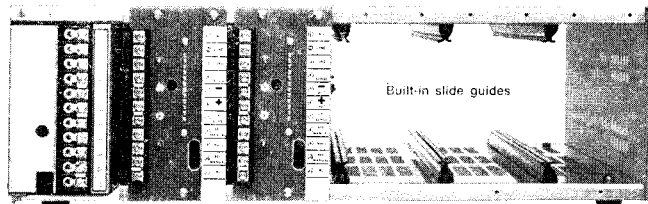

FIG. 1-1 KEPCO CC CURRENT REGULATOR,
TYPICAL (UNCASED) MODULE

**FIG. 1-2 KEPCO ACCESSORIES
FOR PLUG-IN MODULES**



Rear view of the RA 22-6 Housing with one VP-PX Overvoltage Protector mounted (on far left) and 2 PC-2 Connectors installed

PLUG-IN CONNECTOR BOARD Model PC-2
One PC-2 must be ordered for each active slot in the RA 22-6.

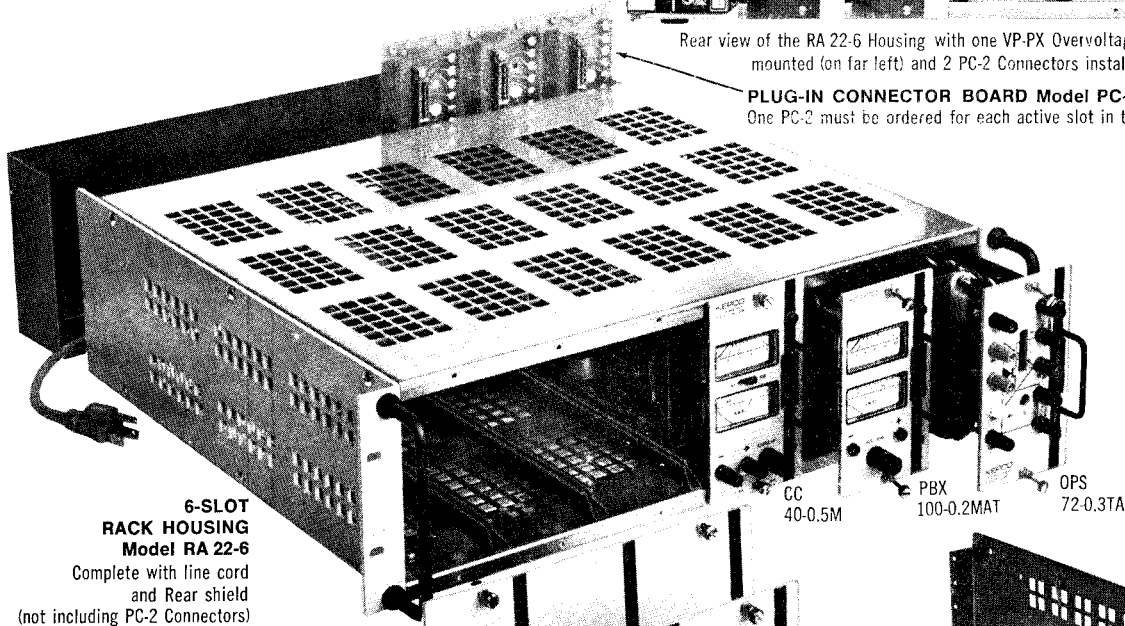

**6-SLOT
RACK HOUSING
Model RA 22-6**

Complete with line cord
and Rear shield
(not including PC-2 Connectors)

CC 40-0.5M PBX 100-0.2MAT OPS 72-0.3TA

FILLER PANELS
(supplied without slide
assembly and handle), may
be used to fill unused slots
in CA-3, CA-4, CA-5 and RA 22-6.

**MODEL
RFP 22-3**

**MODEL
RFP 22-2**

**MODEL
RFP 22-1**

**BLANK SLIDE
ADAPTER
Model BPA-22**
For mounting accessory equipment.
May also be used with standard
OPS, PAX and PBX modules for blank
panel mounting in RA 22-6, CA-3,
CA-4 and CA-5 housings.

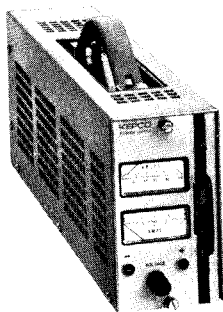

SINGLE UNIT HOUSING Model CA-3
Supplied complete with a built-in PC-2 connector.

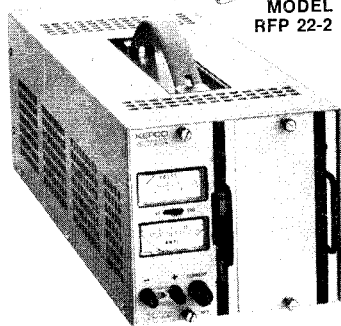

DOUBLE UNIT HOUSING Model CA-4
Supplied complete with a built-in dual PC-2 connector.

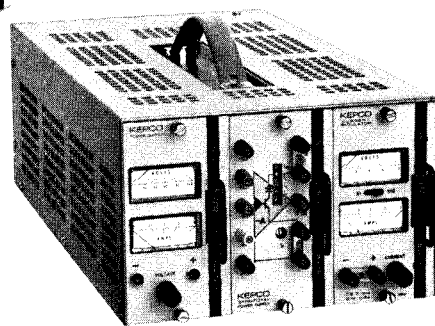

TRIPLE UNIT HOUSING Model CA-5
Supplied complete with a triple PC-2 connector.

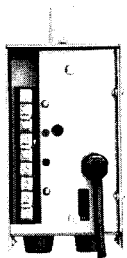

Typical rear view of CA-3, showing
access terminals and connector.

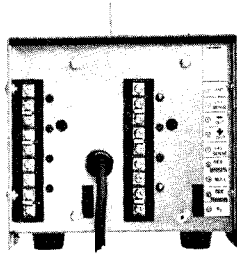

Typical rear view of CA-4, showing integral
connector (Double PC-2) supplied.

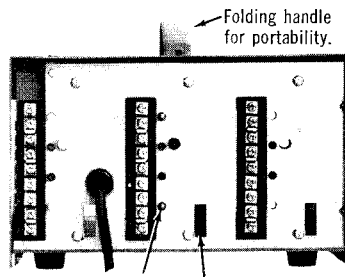

Typical rear view of CA-5, showing
Slot provides access to internal
coding pins, connectors and line cord.

Folding handle
for portability.

SECTION I – INTRODUCTION

1-1 SCOPE OF MANUAL

- 1-2 This manual contains instructions for the installation, operation and maintenance of the Kepco CC Group of CURRENT STABILIZERS.

1-3 GENERAL DESCRIPTION (Refer to FIG. 1-1)

- 1-4 The KEPCO CC GROUP of Current Stabilizers consists of a series of quick-recovery, current stabilized power supplies, able to respond to load changes at rates up to 2 microseconds per volt. Specifically designed as a CURRENT SOURCE, the power supplies in the this group overcome successfully the disadvantages usually associated with standard *voltage* stabilizers converted to supply stabilized *current*:
- In the CC, no shunt output capacity interferes with fast recovery from load voltage changes.
 - In the CC, no parallel loading of the output by conventional metering takes place, since a special integrated circuit, high impedance interface between the output and the metering is used.
 - External sensing resistors or controls are not needed. Linear, high-resolution front panel control of the output current is provided. Sensing resistors, optimized for two output ranges, and selected for low temperature coefficient are built-in.
 - No external offset adjustment required. The CC features special offset circuitry permitting operation from zero to the maximum rated output current.
- 1-5 The CC group of power supplies are as close to the model of an ideal current source as the state of the art permits. An impressive example of the superiority of the CC as a current stabilizer over a conventional voltage/current stabilized supply may be made by comparing their respective recovery times for load changes. Conventional power supplies, operating in a current mode will be delayed by their output filtering to approximately 2×10^2 V/sec., while the capacitorless CC will respond with 0.5×10^6 V/sec.
- 1-6 Specifications and electrical characteristics of all models in the design group are identical, except as noted in Table 1-1. All models are front panel equipped with: two recessed meters, a combination on-off switch and pilot light assembly, output terminals (with shorting-link) and a 10-turn current control, affording full output control over two output ranges. Ranges are switched on a 1:10 range switch which simultaneously switches the ammeter for full scale readout on both ranges.
- 1-7 The CC module is terminated at the rear with a printed circuit board connector. Convenient connections for a-c input, d-c output and remote programming are thus provided. The modular construction of the CC series makes these units equally suitable for either case-mounting or rack installations (refer to par. 1-9, "Accessories").
- 1-8 The power supplies of the CC design group are constructed on a steel frame with the aluminum main chassis and the front panel attached to the frame. Stainless steel guide pins (removable for case installation) are provided for rack-mounting.

1-9 ACCESSORIES (Optional, not supplied. Refer to FIG. 1-2)

- 1-10 Kepco CC modules are supplied without an a-c line cord. A-C power input and/or programming connections must therefore be made via the printed circuit board mating connector or using one of the listed accessories.
- MATING CONNECTOR for uncased operation: KEPCO Model PC-1 or METHODE Model CD-612-S-P7.
 - SINGLE-SLOT HOUSING accepts single CC module and provides all necessary rear terminations, KEPCO Model CA-3 (a-c line cord included).
 - DOUBLE-SLOT HOUSING, KEPCO Model CA-4, accepts two CC modules or mixture,* rear terminations provided, (a-c line cord included).
 - TRIPLE-SLOT HOUSING, KEPCO Model CA-5, accepts three CC modules or mixture,* rear terminations provided, (a-c line cord included).
 - RACK CABINET, KEPCO Model RA 22-6, accepts six CC modules or mixture,* each mounted unit needs a plug-in adaptor (f), (a-c line cord included).
 - PLUG-IN ADAPTOR, KEPCO Model PC-2, required for rack-mounting each plug-in module.

***NOTE:** Multiple-slot housings will accept a mixture of KEPCO modular units (OPS-TA, PBX-MAT), as well as blank-panel inserts such as BPA and RFP.

- g) RACK MOUNT, KEPCO MODEL RA-32, accepts up to three CC modules, or mixture, together with two 1/4 width or one 1/2 width power supply of the type that usually mount in RA-24.
- h) FILLER PANELS
 - 1) KEPCO Model RFP 22-1 to cover (1) empty slot in rack cabinet (RA 22-6), or one of the multiple slot housings (CA-4, CA-5), or one of the 1/6th slots in RA-32.
 - 2) KEPCO Model RFP 22-2 to cover (2) empty slots.
 - 3) KEPCO Model RFP 22-3 to cover (3) empty slots.

1-11 SPECIFICATIONS, GENERAL

- a) A-C INPUT: 105V to 125V a-c or 210V to 250V a-c (selectable), 50 to 440 Hz, single phase. Input current: Refer to Table 1-1.
- b) AMBIENT OPERATING TEMPERATURE: -20°C to +65°C.
- c) STORAGE TEMPERATURE: -40°C to +85°C.
- d) ISOLATION: 500 volts maximum (d-c or p-p) may be connected from chassis to either output terminal.

1-12 SPECIFICATIONS, PERFORMANCE

- a) D-C OUTPUT: Refer to Tables 1-1 and 1-2.

MODEL	D-C OUTPUT		OUTPUT IMPEDANCE OHMS MINIMUM + SHUNT CAPACITY IN μ F	A-C INPUT CURRENT (AT 125V A-C LINE)
	CURRENT	VOLTAGE		
CC 7-2M	0-2A	0-7V	70K +0.2	0.6A
CC 15-1.5M	0-1.5A	0-15V	200K +0.1	0.65A
CC 21-1M	0-1A	0-21V	400K +0.1	0.6A
CC 40-0.5M	0-0.5A	0-40V	1.6M +0.1	0.5A
CC 72-0.3M	0-0.3A	0-72V	4.8M +0.1	0.5A
CC 100-0.2M	0-0.2A	0-100V	10M +0.1	0.5A

TABLE 1-1 D-C OUTPUT AND A-C INPUT, CC GROUP.

NOTE: Kepco has adopted new technical terms recommended by the International Electrotechnical Commission (IEC). These terms replace or supplement previously used expressions, mainly to avoid difficulties in translation and prevent erroneous interpretations at home and abroad.

In this instruction manual Kepco discontinued the use of the specifications entitled "line regulation" and "load regulation" because of the long standing (and misleading) connotation that a power supply regulated the line of the load, instead, Kepco will follow the recommendation of the IEC and speak of the "Output Effects, caused by changes in the influence Quantities." The "Output Effects" are specified either as a percentage change referred to the maximum specified output voltage (E_o) or current (I_o) or as an absolute change (ΔE_o , ΔI_o) directly in millivolts or milliamperes or both. The "Influence Quantities" are the "Source Variations" (formerly a-c line variations), the changes in load, temperature or time as previously specified. The illustration below will clarify the use of the new terminology.

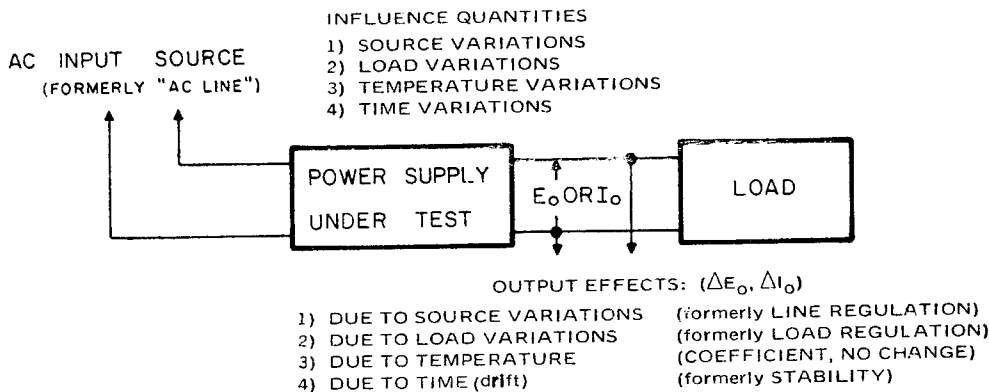

VARIATIONS IN INFLUENCE QUANTITY (Δ)		OUTPUT EFFECTS
Δ A-C INPUT SOURCE:	105 to 125V a-c or 210 to 250V a-c	<0.0005% or 0.2 μ A*
Δ LOAD:	No load to full load	<0.005% or 2 μ A*
Δ TIME:	8 hours (drift)	<0.02% of selected full scale range
Δ TEMPERATURE:	Per °C	<0.01% of selected full scale range

*Whichever is greater.

TABLE 1-2 OUTPUT EFFECTS.

NOTE: While measurements of output effects due to variations in any one influence quantity are performed, variations in all other influences are held constant. This tabulation specifies the maximum change in the stabilized output for each variation of the listed influence quantities. For a "worst case" analysis of the equipment behavior in a given environment, the output effects for each anticipated influence variation must be summed.

- b) OUTPUT RIPPLE: Less than 0.02% of the maximum rated output current (high or low range), true rms, at any operating condition.
- c) CURRENT RECOVERY (from step load voltage): Output current will return to the specified regulation band within 2 μ sec. per volt compliance. (Model CC 7-2M: 4 μ sec. per volt.)

1-13 SPECIFICATIONS, PHYSICAL

- a) Refer to FIG. 1-3, "Mechanical Outline Drawing," for dimensions, materials used and finish.

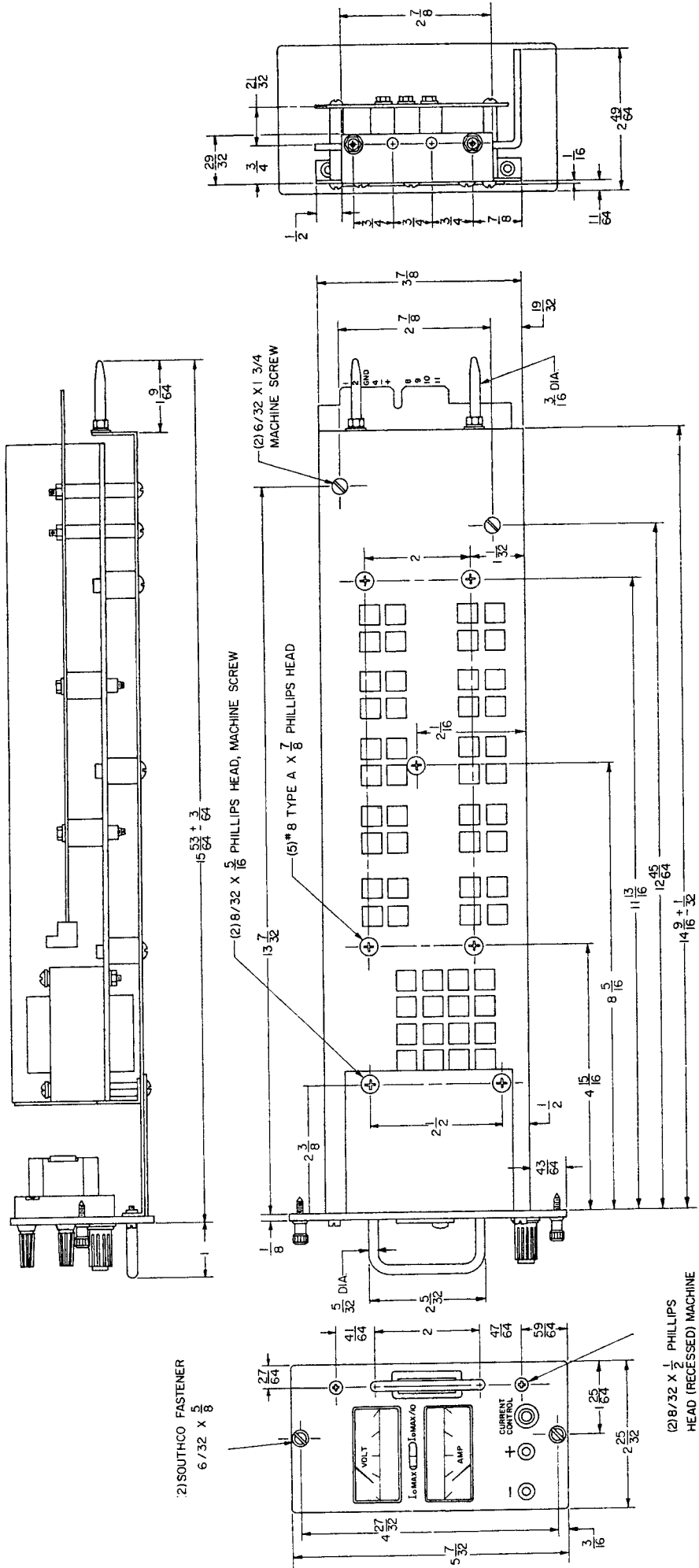

- NOTES:
1. THIS DRAWING IS USED FOR MODELS: CC7-2M, CC15-1.5M, CC21-1M, CC40-0.5M, CC72-0.3M AND CC100-0.2M
 2. MAT'L: CHASSIS, 16 GAUGE COLD ROLLED STEEL, FRONT PANEL 1/8 THICK ALUM.
 3. FINISH: CHASSIS, CADMIUM PLATE WITH A CROMAK WASH. FRONT PANEL, LIGHT GRAY PER FEDERAL STD 595 COLOR No. 26440
 4. REFER TO KEPKO CATALOG FOR DETAILED SPECIFICATIONS

FIG. 1-3 MECHANICAL OUTLINE DRAWING, CC-DESIGN GROUP

SECTION II – INSTALLATION

2-1 UNPACKING AND INSPECTION

2-2 This instrument has been thoroughly inspected and tested prior to packing and is ready for operation. After careful unpacking, inspect for shipping damage before attempting to operate. Perform the preliminary operational check as outlined in paragraph 2-11 below. If any indication of damage is found, an immediate claim with the responsible transport service must be entered.

2-3 TERMINATIONS

- a) FRONT PANEL: Refer to FIG. 2-3 and TABLE 2-2.
- b) REAR: Refer to FIG. 2-2.
- c) INTERNAL ADJUSTMENTS: Refer to TABLE 2-1 and FIG. 2-1.

REFERENCE DESIGNATION	ADJUSTMENT	PURPOSE	ADJUSTMENT PROCEDURE
R15	I_o MAXIMUM	OVERLOAD CURRENT CONTROL	PAR. 5-11
R18	E_{i0} NULL	ZERO CURRENT CONTROL	PAR. 3-17
R19	LAG NETWORK	A-C STABILITY CONTROL	PAR. 5-7
R23	I_b ADJUST	CONTROL CURRENT CALIBRATION	PAR. 3-17

TABLE 2-1 INTERNAL CONTROLS.

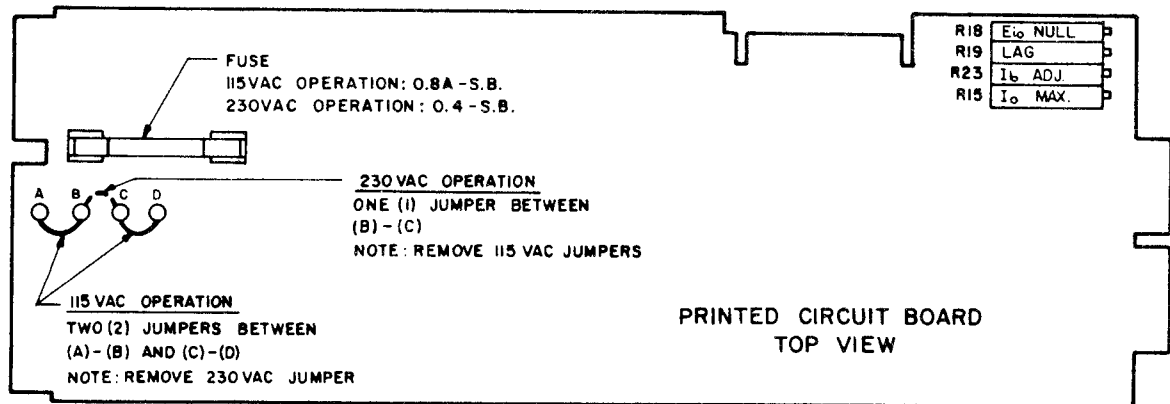

FIG. 2-1 LOCATION OF SOURCE SELECTOR AND INTERNAL ADJUSTMENTS.

2-4 A-C POWER REQUIREMENTS

2-5 CC Current Stabilizers are normally delivered for operation on a single phase, 105 to 125V a-c input source, 50 to 440 Hz. For operation on 210 to 250V a-c input sources, the jumper connections for the main transformer (T201) must be changed as shown in FIG. 2-1.

2-6 PROCEDURE FOR CONVERSION TO 230V A-C INPUT SOURCE OPERATION

- a) Disconnect power supply from a-c input source.
- b) Remove bare wire jumpers between terminals (A) and (B) as well as (C) and (D).
- c) Connect bare wire jumper between jumper terminals (B) and (C).
- d) Insert correct fuse value. (See FIG. 2-1.)

2-7 SAFETY (A-C) GROUNDING

WARNING

- 2-8 For safety it is imperative that the metal chassis be kept at ground potential. If a 3-wire safety a-c input cord and a properly grounded outlet is used, this is taken care of automatically. However, if only a 2-wire a-c input cord or an adaptor for a 3-wire, a-c input cord is used, the pigtail wire of the adaptor or the metal chassis of the power supply must be returned to a good a-c ground via P1-3 or terminal (3) on the PC-2.

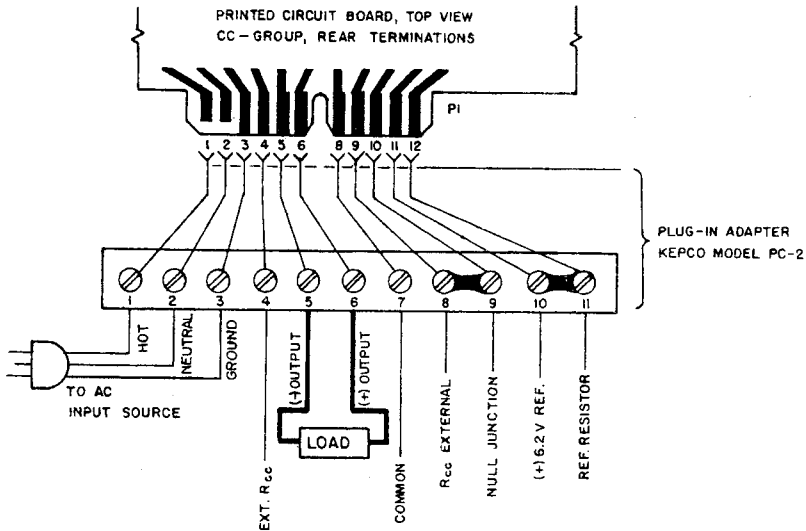

FIG. 2-2 REAR TERMINATIONS.

NOTE: If PC-2, optional plug-in adaptor is not used jumper connections must be provided on the mating jack for P1, the connector on the CC module, between pins (11)-(12) and (9)-(10).

CAUTION

Before a-c turn-on either the load must be connected to front or rear output terminals, or the shorting link must be in place.

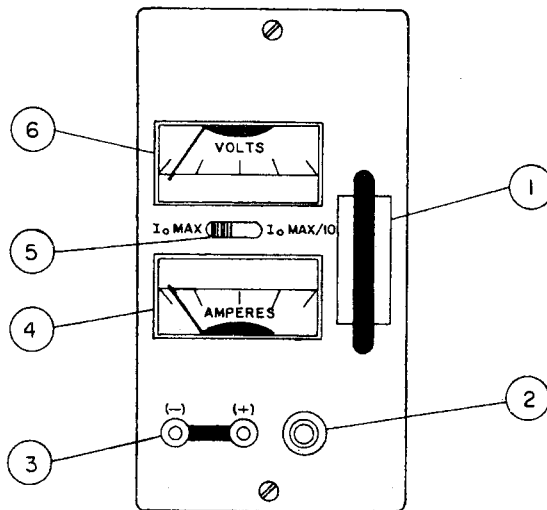

FIG. 2-3 TERMINATIONS AND CONTROLS, FRONT PANEL.

NO.	TERMINATIONS OR CONTROL
1.	A-C POWER SWITCH AND PILOT LIGHT COMBINATION (SDS101).
2.	10-TURN OUTPUT CURRENT CONTROL (R101).
3.	OUTPUT TERMINALS, REMOVE LINK FOR LOAD CONNECTION.
4.	OUTPUT CURRENT METER (M101), Scales: I_o max. and I_o max/10.
5.	OUTPUT CURRENT RANGE SELECTOR: 0 - I_o max, 0 - I_o max/10.
6.	OUTPUT VOLTAGE (COMPLIANCE) METER (M102).

TABLE 2-2 TERMINATIONS AND CONTROLS, FRONT PANEL.

2-9 D-C (SIGNAL) GROUNDING AND ISOLATION

- 2-10 The d-c output terminals of the CC Current Stabilizer are isolated from the a-c power line and from the chassis. Since no d-c connection to the chassis exists, either side of the supply may be grounded or a maximum of 500V (d-c or a-c peak-to-peak) can be connected between chassis and either output terminal.

2-11 PRELIMINARY CHECK-OUT PROCEDURE

CAUTION

An *open circuit* represents a fault condition for a current source (the equivalent of a *short circuit* for a voltage source). Current stabilizers in the CC Design Group must therefore be operated with a load across the output at all times. (Fixed voltage limiting at about 150% of the rated compliance is provided, the actual value depending upon the a-c input source.)

- 2-12 Before final installation a simple functional check may be performed as follows:
- a) Refer to rear termination diagram (FIG. 2-2) and par. 2-4 for correct primary a-c connections. Connect supply to power line.
 - b) With the supplied shorting link across the output terminals, turn A-C POWER switch "on." The a-c indicator light (part of A-C POWER switch) should energize. Turn the CURRENT CONTROL slowly through its range and observe the OUTPUT CURRENT METER. The output current should increase smoothly from zero to the maximum rated output current. The OUTPUT VOLTMETER will remain at zero, since the voltage output (compliance) is zero under short-circuit condition. If voltmeter test is desired, refer to SECTION III for load resistor selection. Shut A-C POWER SWITCH "off." This concludes the preliminary check-out.

2-13 INSTALLATION

- 2-14 Kepco modular plug-in type power sources offer a wide variety of mounting possibilities (Refer to par. 1-9, ACCESSORIES). Whether single case, multiple housing or rack-installation is planned, installation consists simply in carefully sliding the module into one of the cabinets, making certain the printed circuit board connector of the unit has made positive contact with mating plug in the housing. Once the two holding screws on top and bottom of the front panel have been fastened, the unit is ready for operation.

2-15 COOLING

- 2-16 Modular units installed in single or multiple housing or in rack cabinets must have sufficient air flow for effective convection cooling. Perforated side covers and tops must be kept clear from obstructions. In rack-installations, care must be taken that the temperature inside the rack does not exceed the specified ambient temperature. Where large amounts of heat are dissipated within the cabinet, power supplies should be "force air cooled."

SECTION III – OPERATION

3-1 OPERATING CONSIDERATIONS FOR CURRENT STABILIZERS

- 3-2 For users not thoroughly familiar with stabilized current sources, a few general remarks about these devices may be in order. The properties which distinguish a current stabilizer can perhaps best be shown by analogy with an equivalent voltage stabilizer. For any given range of load resistances, the latter keeps its output voltage constant, while its load current tracks the value of the load resistance. A current stabilizer, on the other hand, keeps its output current constant, while its output voltage "complies" with the demands of the load resistance and changes accordingly. (For this reason, the output voltage of a current stabilizer is sometimes termed the "Compliance Voltage.")
- 3-3 The CC Current Stabilizer has a load range (0 to $R_L \text{ max.}$), the limit of which ($R_L \text{ max.}$) is determined by its maximum rated compliance voltage ($E_O \text{ max.}$) and the specific output current value (I_{OS}), set by the front panel output current control (or by a remote control): $R_L \text{ max.} = E_O \text{ max.} / I_{OS}$; (Eq. 1) where " $R_L \text{ max.}$ " represents the MAXIMUM load resistance which can be connected across the output of the CC Current Stabilizer for a specific value of the output current (I_{OS}), set by the current control, and $E_O \text{ max.}$ is the maximum rated output (compliance) voltage of the particular CC model.
- 3-4 By means of the equation above (Eq. 1) one can quickly determine whether a specific CC model is suitable for delivering stabilized output current to a given load when the load requirements are defined. If the load resistance *exceeds* the value derived from the equation (Eq. 1), loss of stabilization results, since the CC Current Stabilizer can, under the conditions given by Eq. 1, no longer supply the necessary (higher) compliance voltage. For any load resistance *lower* than that derived from Eq. 1, the CC Current Stabilizer will adjust its compliance voltage to the appropriate value, while keeping the output current stabilized. The load range for any given output current (I_{OS} , set by the current control) is, therefore, from zero to $R_L \text{ max.}$, where " $R_L \text{ max.}$ " is derived from Eq. 1. An illustration of the above discussion is provided by FIG 3-1, while the output ratings of *all* CC models are listed in Table 3-1.

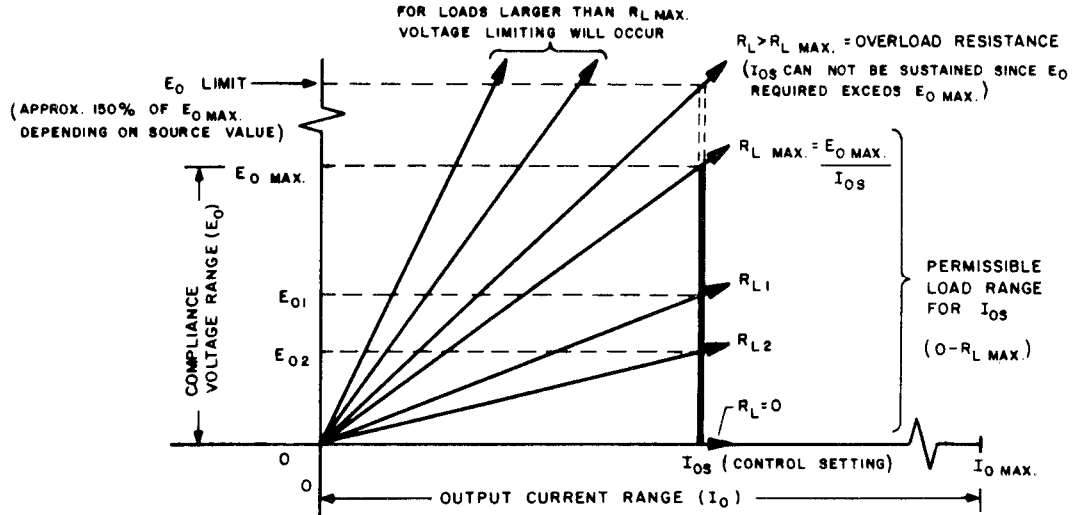

FIG. 3-1 LOAD RANGE FOR CURRENT STABILIZER

MODEL	LOAD RANGE (AT $I_O \text{ MAX.}$)	COMPLIANCE VOLTAGE RANGE (E_O)	OUTPUT CURRENT RANGE (I_O)
CC 7-2	0-3.5 ohms	0-7 volts	0-2 amperes
CC 15-1.5	0-10 ohms	0-15 volts	0-1.5 amperes
CC 21-1	0-21 ohms	0-21 volts	0-1 ampere
CC 40-0.5	0-80 ohms	0-40 volts	0-0.5 ampere
CC 72-0.3	0-240 ohms	0-72 volts	0-0.3 ampere
CC 100-0.2	0-500 ohms	0-100 volts	0-0.2 ampere

TABLE 3-1 LOAD RANGES, CC SERIES.

3-5 STANDARD OPERATION, LOCAL CONTROL

3-6 With the CC rear PCB connector terminated either with a simple mating connector, the PC-2 plug-in adaptor (rack-mounted) or a case adaptor, the unit may be connected to the a-c power source and is ready for operation. The load may be connected to the rear barrier-strip or the front terminals. Standard jumper-link connections are shown in FIG. 3-2 below. Links and load connections must be tight and secure for proper operation. If no external load is connected, the output terminals must be shorted by link or other connection to provide a path for the current.

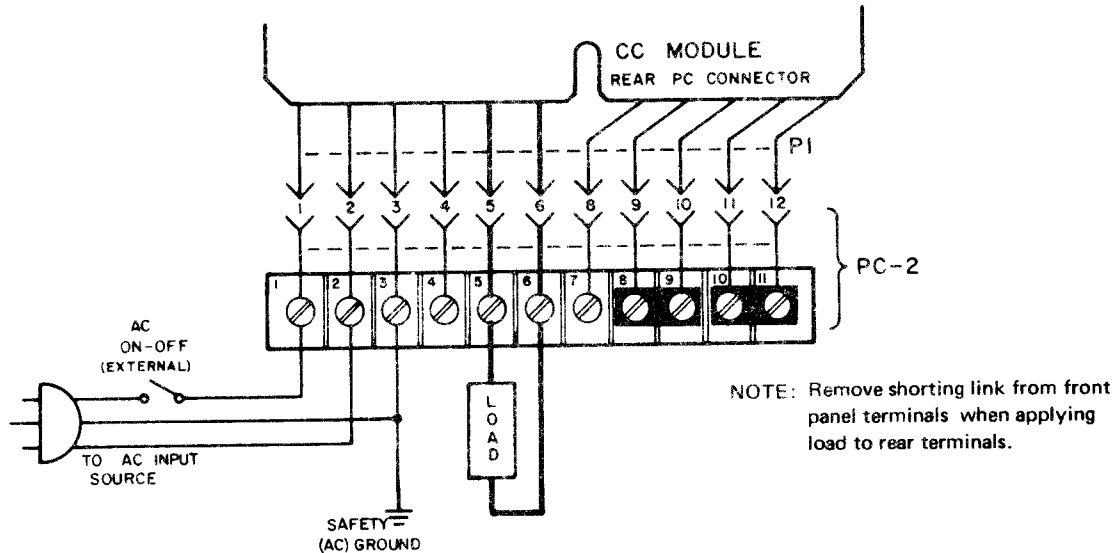

FIG. 3-2 REAR TERMINATIONS FOR STANDARD LOCAL OPERATION.

3-7 The connection diagrams in this section (see FIG. 3-2) show the barrier-strip terminations on the plug-in adaptor (part of any cased unit) and on the equivalent PC-2 adaptor (part of any rack-mounted unit). If the uncased unit is to be terminated by the mating connector for the printed circuit plug (P1) only, the jumper links shown on the barrier-strip adaptor (PC-2) must be duplicated by wire jumpers on the mating jack for the rear PC connector (P1).

NOTE: 1) SINCE THE KEY ON P1 TAKES THE PLACE OF PIN #7, THE BARRIER-STRIP TERMINAL NUMBERS DO NOT CORRESPOND TO THE PIN NUMBERS ON P1.

NOTE: 2) A FOLD-OUT DIAGRAM IS PROVIDED AT THE END OF SECTION III, RELATING THE BARRIER-STRIP CONNECTIONS, SHOWN IN ALL OPERATING DIAGRAMS, TO THE CIRCUITRY OF THE CC MODULE.

NOTE: 3) REFER TO SECTION II (FIG. 2-3) FOR THE LOCATION OF ALL OPERATING CONTROLS.

3-8 The OUTPUT CURRENT RANGE SELECTOR should be placed according to the operating range desired. Two ranges are available:

- In the " $I_{Omax.}$ " position, the full output current ($I_{Omax.}$) of the unit is available and the ammeter reads on its upper scale.
- For applications requiring less than one-tenth ($I_{Omax.}/10$) of the rated output current, the OUTPUT CURRENT RANGE SELECTOR should be placed in the " $I_{Omax.}/10$ " position. In this position, only one-tenth of the output current is available and the ammeter reads on its lower scale.

3-9 The purpose of the OUTPUT CURRENT RANGE SELECTOR is to provide the best current stabilization at low output currents. This range switch is not a meter range switch; i.e., it will not show the same output current on a different meter scale when activated. Although it will operate the ammeter on a lower scale, this function is only incidental to its main purpose, namely to switch output ranges.

CAUTION

EXTREME CARE SHOULD BE EXERCISED WHEN SWITCHING OUTPUT RANGES UNDER LOAD. ALTHOUGH THE FRONT PANEL AMMETER IS PROTECTED, A 10:1 CURRENT INCREASE MAY DAMAGE A SENSITIVE LOAD.

3-10 INTRODUCTION TO THE CONTROL EQUATION

3-11 To familiarize the user with the terminology and the basic equations pertaining to the CC, a simplified analysis of the circuit will be presented and the transfer function derived. The significant electrical components of the current stabilizer circuit can be represented as shown in FIG. 3-3.

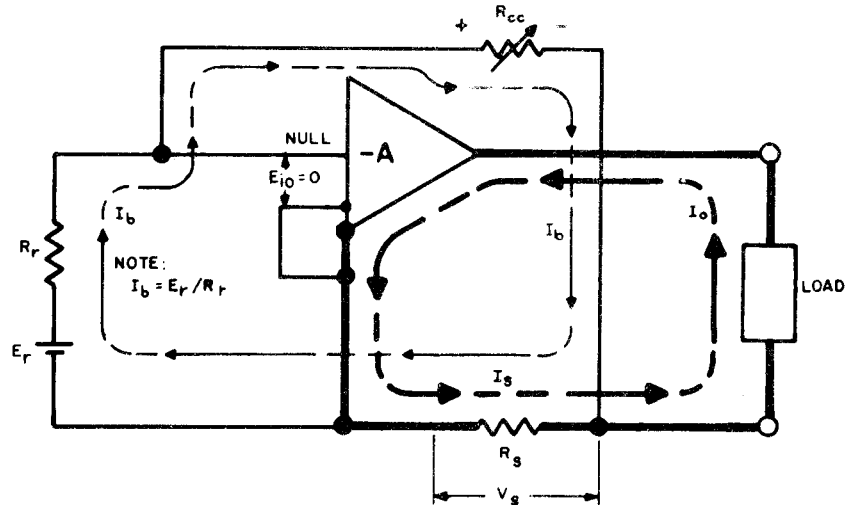

FIG. 3-3 IDEAL CURRENT STABILIZER.

3-12 The Kepco CC Current Stabilizer employs a simple comparison circuit using an integrated operational amplifier with high gain and low bias current to obtain a true null terminal, at which the output current, sampled across R_s , can be compared with a zener stabilized reference (E_r) through a pair of proportioning resistors, R_r and R_{cc} . R_r is made trimmable and is used for calibration; R_{cc} is a variable rheostat, either the front panel current control or an external programming resistance.

The voltage across the amplifier's input terminals, forming the null is E_{i0} .

Assuming that E_{i0} is 0, the reference E_r establishes a current $I_b = E_r/R_r$ and

$$I_b R_{cc} + (I_b - I_o) R_s = E_{i0} = 0.$$

$$\text{Therefore: } I_b R_{cc} + I_b R_s = I_o R_s$$

$$\text{and } I_o = I_b \left(\frac{R_{cc}}{R_s} + 1 \right) \text{ which limits } I_o = I_b \text{ as } R_{cc} \rightarrow 0.$$

3-13 In the CC models, a special zeroing control is provided to offset E_{i0} from zero by an amount equal to $I_b R_s$.

$$\text{Thus: } I_b R_{cc} + (I_b - I_o) R_s = I_b R_s \text{ (not zero).}$$

$$\text{and: } I_b R_{cc} - I_b R_s + I_b R_s = I_o R_s$$

cancelling terms $I_o = \frac{I_b R_{cc}}{R_s}$ a simpler expression in which I_o approaches zero, as $R_{cc} \rightarrow 0$.

3-14 Other modes of output control include remote voltage programming by retaining a fixed gain factor (R_{cc}/R_s) and replacing the internal (fixed) reference voltage by an external variable control voltage. The output can also be controlled by inverse resistance (conductance) variations making the reference resistor (R_r) adjustable. Some of the many possible programming methods are described and illustrated in the following paragraphs.

3-15 ADJUSTMENTS FOR PRECISION PROGRAMMING RATIO

3-16 All current stabilizers in the CC group are factory-adjusted for an output range from zero to their maximum rated current (on both operating ranges) with the CURRENT CONTROL at its maximum counterclockwise and clockwise position, respectively. Since a "sensing voltage" (V_S) of 1 volt (at maximum output current) is used for both ranges, and the control resistor (R_{CC}) has a value of 10 K ohm, a "programming ratio" of 10,000 ohms per volt of sensing results for the internal control system. This control ratio may be retained when programming externally, or it can be altered, keeping in mind that $V_S = 1V$ at maximum output current. In either case, when using external resistance to control the output, the programming ratio must be readjusted if precise results are expected. Adjustment procedures for the standard as well as for a modified programming ratio are given below.

3-17 PROCEDURE FOR PROGRAMMING RATIO ADJUSTMENT (STANDARD)

- a) With the external programming resistor connected as shown (Refer to FIG. 3-4), and a precision ammeter in series with the load (optional, since the panel ammeter may be used if an accuracy of $\pm 3\%$ is sufficient), locate the " I_b adj." and " E_{i0} null" controls on the printed circuit board (Refer to FIG. 2-1).

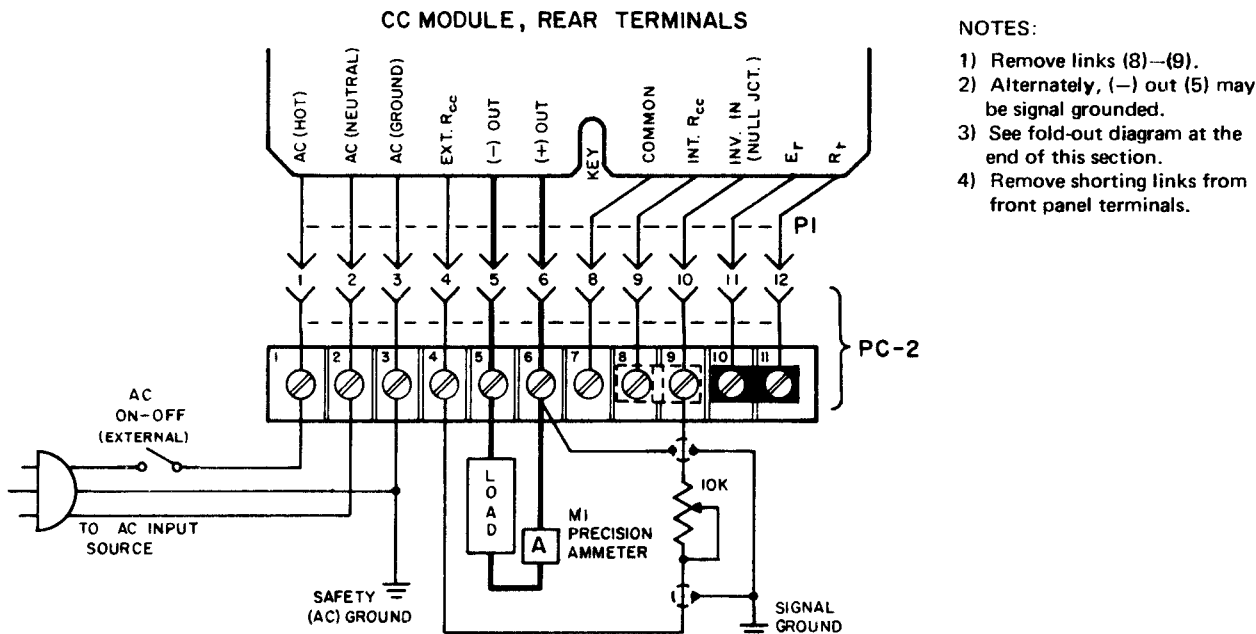

FIG. 3-4 PROGRAMMING RATIO ADJUSTMENT FOR REMOTE RESISTANCE CONTROL.

- b) With the external "Current Control" at zero ohms, adjust " E_{i0} null" (R18) until zero output current is read out on the ammeter (M1).
- c) With the external "Current Control" at 10 K ohms, adjust " I_b adj." (R23) until maximum output current is read out on the ammeter (M1).
- d) Recheck zero (b). This concludes the programming ratio adjustment.

3-18 REMOTE RESISTANCE PROGRAMMING

3-19 The output current of the CC Current Stabilizer may be varied by means of an external current control resistance connected between rear terminals (4) and (9). If the standard control ratio is retained (see par. 3-17 for precision adjustment), a total resistance of 10 K ohms will control the output from zero to the maximum rated output current in either range. The control resistance may be fixed, continuously adjustable, or step-controlled or it may be a combination of these.

3-20 CAUTION. When fixed resistors are switched or step-controlled, the switching device must have "make before break" contacts, so that the control circuit does not open during transfer. Programming resistors should be high quality units, with low temperature coefficients (20 ppm or better).

- 3-21 CC Current Sources may be remote controlled by other than the standard programming ratios. If for example a precision rheostat of 3000 ohms is available, a simple adjustment will allow the user to control the output over both ranges.
- 3-22 PROCEDURE FOR PROGRAMMING RATIO ADJUSTMENT (NONSTANDARD).
- Proceed exactly as described in par. 3-17a. In addition, connect a 40 K trim-rheostat between rear terminals (9) and (10). (Refer to FIG. 3-5.)

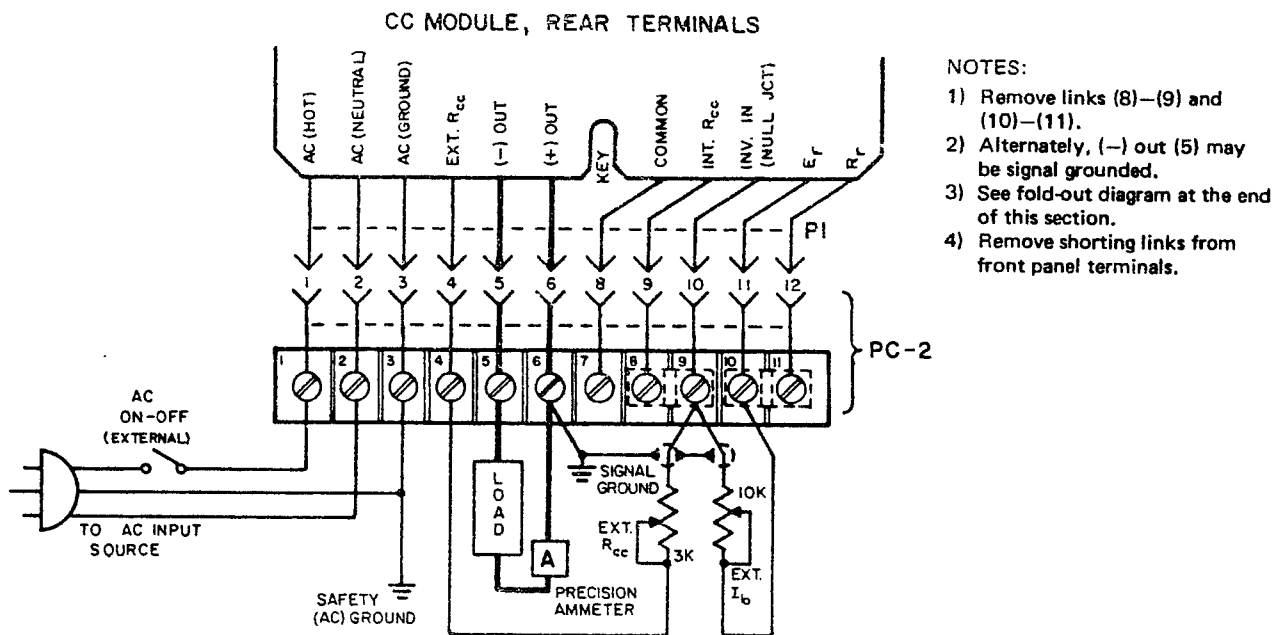

FIG. 3-5 RESISTANCE PROGRAMMING AND ADJUSTMENT FOR NONSTANDARD PROGRAMMING RATIO.

- With the external "Current Control" at zero ohms, adjust "E_{i0} null" (R18) until zero current is read-out on the ammeter (M1).
- With the external "Current Control" at 3000 ohms, adjust the external "I_b adjust" until maximum rated current is read-out on the ammeter.
- Recheck zero. This concludes the programming ratio adjustment. The output current can now be adjusted from zero to its maximum value on either range.

3-23 REMOTE PROGRAMMING BY A CONTROL VOLTAGE SOURCE

3-24 The output current of the CC Current Stabilizer can be controlled by means of an external signal voltage. This external signal voltage (E_i) now provides the necessary control current (I_b) formerly delivered by the (fixed) internal reference source (E_r). Using the previously derived simplified transfer function, we can write:

$$I_o = E_i/R_i(R_{CC}/R_s) \text{ and: } E_i/R_i = I_b$$

where the new terms are the external signal source (E_i) and the input resistor (R_i), which should always be selected such that E_imax./R_i = 0.1 mA = I_b if the internal front panel current control resistor (R_{CC}) is used with the internal sensing resistor (R_s). Other values of programming current (I_b) may be chosen if the internal current control (R_{CC}) is replaced with an external component. (See par. 3-21, 3-22 for programming with nonstandard programming ratio.)

- 3-25 Voltage programming with the CC may be performed simply by disconnecting the internal reference source (E_r) (opening terminals [10]–[11] on the rear barrier-strip) and replacing it with the external control voltage (E_i) and the proper coupling resistor (R_i). Varying E_i will now change the output current proportionally. (Refer to FIG. 3-6.) R_i is selected such that E_imax./0.1 mA = R_i.
- 3-26 Due to its considerable bandwidth and slewing speed, the CC Current Stabilizer can be effectively used as a unipolar amplifier with potentially high power gain. It must be remembered, however, that the CC is a unipolar device. Since its output can only vary in one direction, the input source must also be unipolar (positive-going with respect to the "Common" terminal) or, the d-c output level must first be set (by d-c biasing, using the internal reference source) in such a way that it can accommodate the amplified signal if the input is bipolar. An example of programming with a bipolar input source is given below.

CC MODULE, REAR TERMINALS

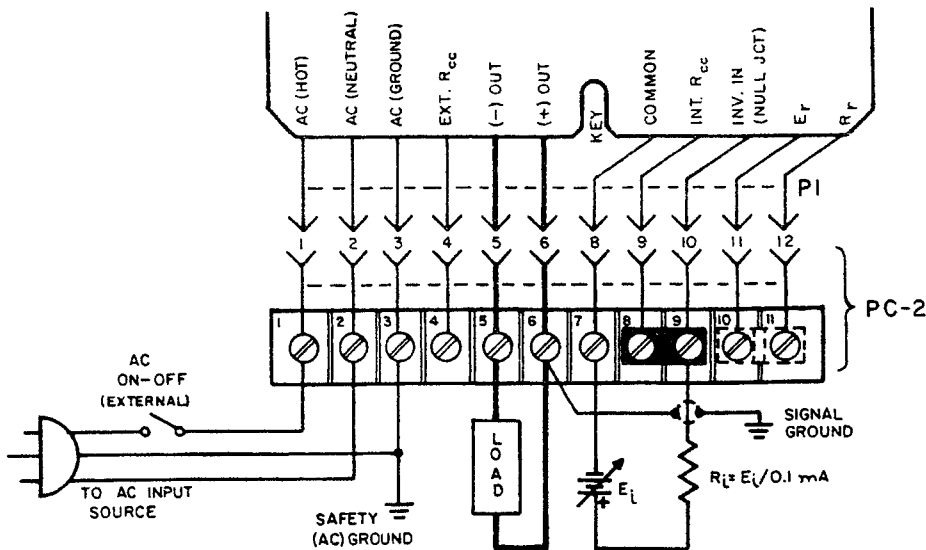

- NOTES:
- 1) Remove links (9)–(10).
 - 2) Either (+) output, as shown, or (-) output may be signal grounded.
 - 3) See fold-out diagram at the end of this section.

FIG. 3-6 REMOTE OUTPUT CURRENT CONTROL BY VOLTAGE.

3-27 Example: A Model CC 100–0.2M is to be sine-wave programmed over its full output current range from a generator having a bipolar output of 2V peak-to-peak and an output impedance of 600 ohms. Since the external programming signal is *BIPOLAR* and the CC Current Stabilizer can only respond in *one* direction (positive with respect to the common [+]) output terminal). The output of the CC Current Stabilizer must first be set to a d-c output level which can accommodate the output signal swing. Since the maximum output current of this particular model is 0.2A, assume the d-c output will be set to 0.1A, so that the amplified sine wave signal can swing equally "around" the d-c bias level of 0.1A. (See FIG. 3-7.)

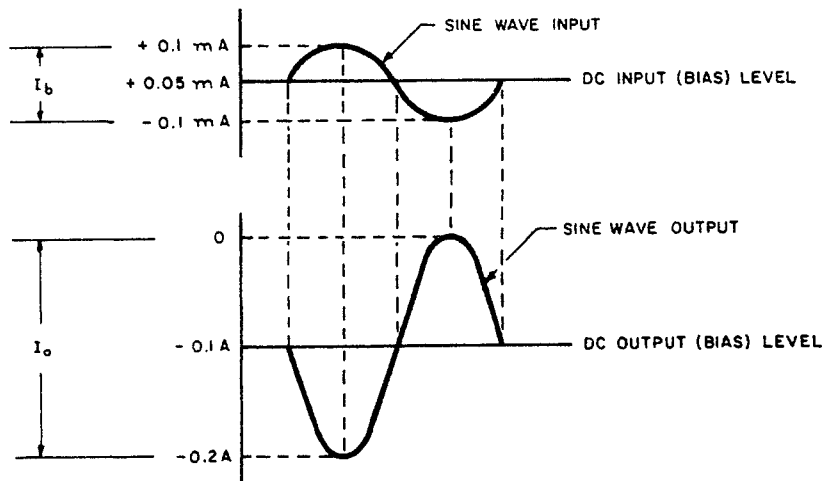

FIG. 3-7 SINE WAVE PROGRAMMING.

3-28 With the front panel current control in the maximum *clockwise* position, the CC Current Stabilizer yields maximum rated output for a fixed control current (I_b) of 0.1 mA. If we supply *one half* of I_b (0.05 mA) from the fixed reference source and the *other half* (± 0.05 mA) of I_b from the external programming source, the following expression can be written:

$$I_o = (I_{b1} \pm I_{b2})(R_{cc}/R_s)$$

where I_{b1} is the fixed reference current which produces the d-c output bias (0.1A d-c) and I_{b2} is the programming signal which is constantly changing in polarity and therefore produces the sine wave output around the d-c bias level. (See FIG. 3-7.) It remains to determine the component values necessary to complete the programming circuit:

- a) The standard control current (I_b) must be reduced to one-half its former value ($I_{b1} = 0.05$ mA). This is accomplished by introducing an additional series resistance into the d-c reference voltage circuit. Remove rear link (10)–(11) and connect a 100 K rheostat in place of the link. The rheostat is adjusted later to the exact output level of 0.1A d-c.

- b) To produce ± 0.05 mA control current (I_{b2}) from the 2V signal source (E_i), the series resistor (R_i) must be: $2V/0.05 \text{ mA} = 40 \text{ K ohms}$.
- c) Connect the external programming source, the load, and the calculated resistors to the CC barrier-strip as shown in FIG. 3-8. Turn the CC Current Stabilizer "on." With a momentary short circuit between rear terminals (4) and (8), adjust ZERO CURRENT CONTROL ("E_{i0} Null" = ZERO CURRENT CONTROL, R18) to zero output current. Remove short and adjust external 100 K rheostat for 0.1A output. Turn on signal generator and adjust amplitude for maximum sine wave output without distortion, as observed on an oscilloscope across the output terminals (5)–(6).
- d) After the programming set-up has been connected as shown in FIG. 3-8, operation can commence. The sine wave frequency response of the CC under the operating conditions described will be approximately 1.6 kHz, calculated by the relation:

$$f_{\max.} = \frac{\text{SLEWING RATE}}{2\pi E_p} \text{ where } f_{\max.} \text{ equals the maximum (undistorted) sine wave frequency,}$$

and E_p the peak excursion (1/2 p-p) of the compliance voltage. The "Slewing Rate" of the compliance voltage is equivalent to the specified "Current Recovery," $2 \mu\text{sec. per volt}$ or $5 \times 10^5 \text{ V/sec}$. Inserting the known values into the equation shown, the result is:

$$f_{\max} = \frac{5 \times 10^5 \text{ V/sec.}}{6.28 \times .5 \times 10^2 \text{ V}} \approx 1.6 \times 10^3 \text{ Hz, or 1.6 kHz.}$$

If the input signal frequency is raised beyond the calculated figure, slope distortion will set in.

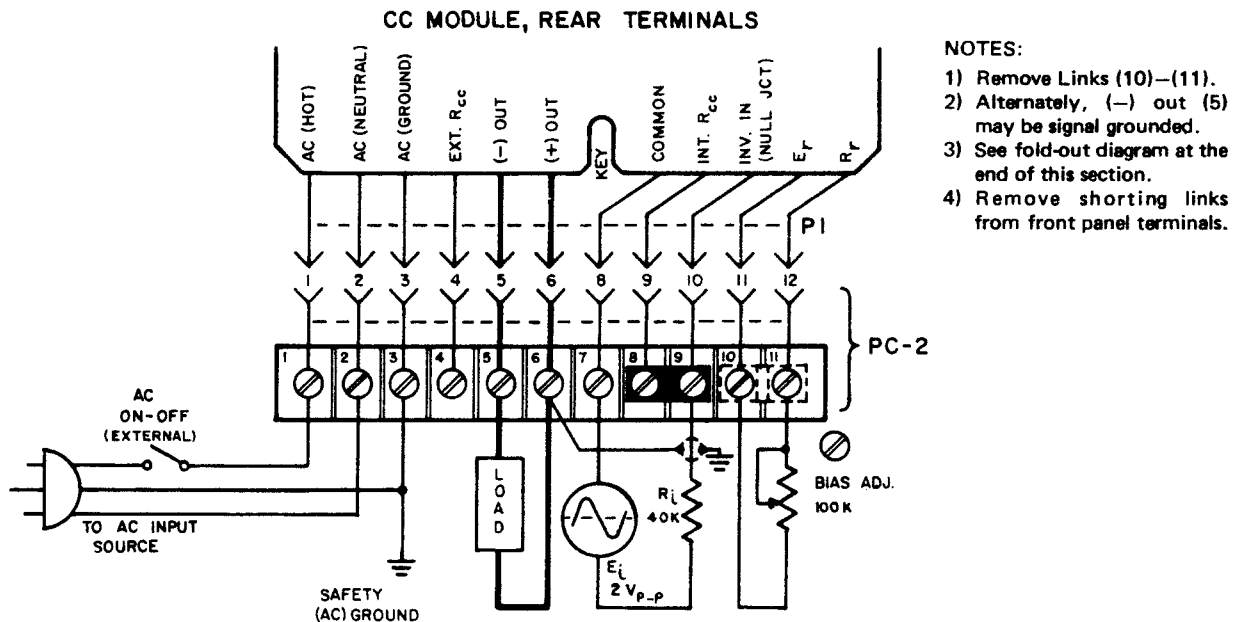

FIG. 3-8 CONNECTIONS FOR SINE WAVE PROGRAMMING.

3-29 Another interesting way of controlling the output current by an external voltage is to connect the programming source directly into the feedback terminals of the current stabilizer. Since the built-in sensing resistors are designed to drop 1 volt at full output current, a 1 volt source connected as shown in FIG. 3-9 will program the CC from 0 to I_o max., as the programming source is varied from 0 to 1 volt.

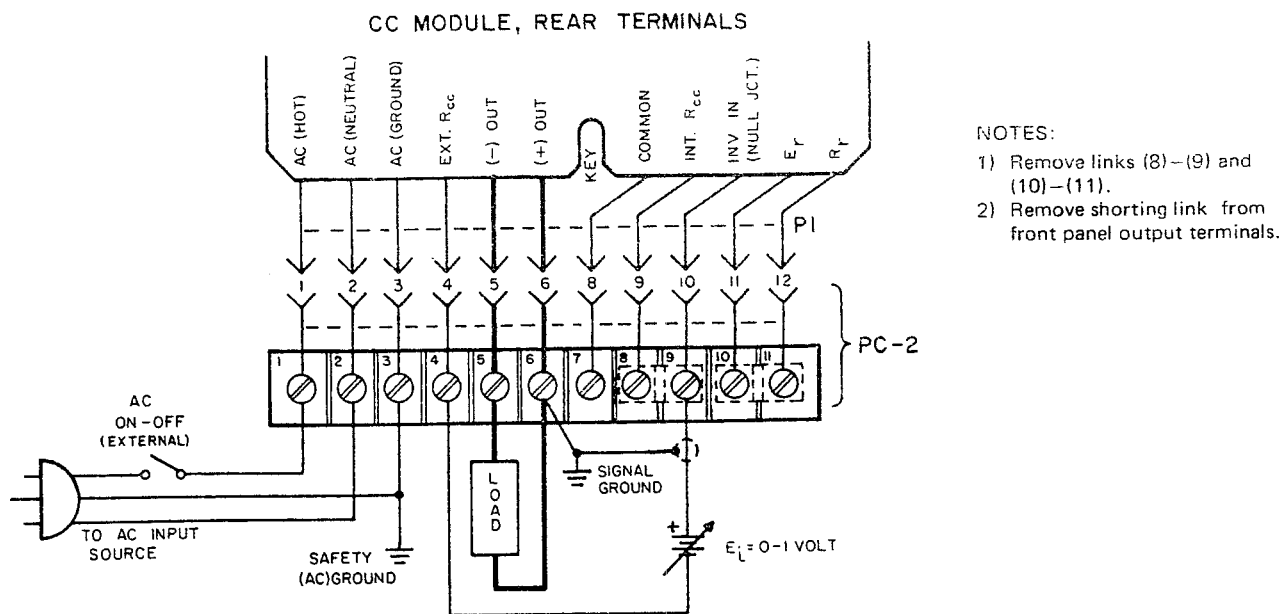

FIG. 3-9 CONNECTIONS FOR D-C VOLTAGE PROGRAMMING.

3-30 EXTENSION OF THE POWER SUPPLY RANGE BY PARALLEL CONNECTION

3-31 GENERAL. Current stabilized power supplies can be paralleled to increase the load current. Certain precautionary methods are needed to protect the load as well as the power supply from malfunctions. If the "Master/Slave" circuit is used for parallel operation, programming of the "master" unit may be performed as described for the single power supply earlier in this section. All programming equations as presented for the single unit are applicable, except that the output quantity must be multiplied by the number of units in the parallel connection. Details for parallel operation are presented in the following paragraphs.

3-32 PARALLEL CONNECTION OF CC POWER SUPPLIES. When paralleling current stabilizers, the supplies should preferably have identical compliance voltage ranges. If supplies with different output voltages are used, an accidentally open circuit in the load would result in a terminal voltage equal to that of the highest rated supply in the parallel combination. If the lower voltage supply cannot absorb the resulting reverse current flow, damage could result. If it is necessary to parallel supplies with different compliance voltage ranges, the supplies should be individually protected by means of a semiconductor diode, in series with each output. (Refer to FIG. 3-10.) Since the diode is normally conducting, it must be capable of passing the maximum rated output current of the power supply, while its reverse voltage rating must be higher than the compliance (output voltage) rating of the highest rated supply in the parallel combination. Two basic methods for paralleling current stabilizers are generally used; the "Automatic" parallel connection (as shown in FIG. 3-10) and the "Master/Slave" connection (as shown in FIG. 3-11). The basic difference between the two connections consists in the method of output control of the parallel units. While in the "Automatic" connection, the output of each supply may be controlled individually. In the "Master/Slave" connection only the "master" supply is controlled, while the "slave" output follows the command of the "master" supply in a ratio which may be predetermined by the user. The latter method of parallel connection is therefore often termed the "Automatic Tracking" mode.

3-33 The connection shown (in FIG. 3-11) will deliver exactly twice the output current of the master supply if power supplies with identical output ratings are used. If identical units are not available, the total output current is the sum of the master unit and the slave. In this case, the output current of the slave unit will always be exactly proportional to that of the "master" supply in the ratio I_{Om}/I_{Os} , where I_{Om} and I_{Os} are the maximum rated output currents of the master and slave units respectively. If I_{Om} is, for example, 10 amperes and I_{Os} is 5 amperes res, the 2:1 ratio will always be maintained as the master supply is controlled throughout its range.

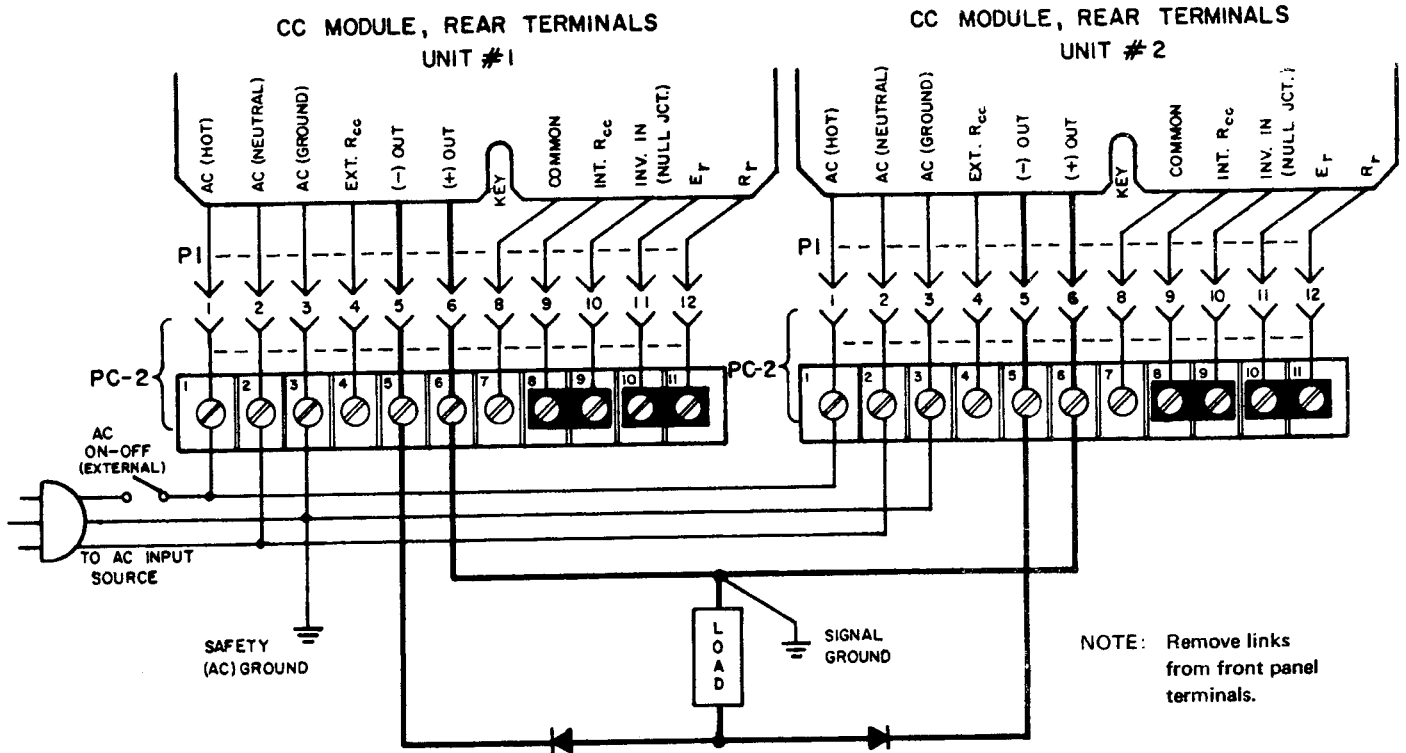

FIG. 3-10 "AUTOMATIC" PARALLEL CONNECTION.

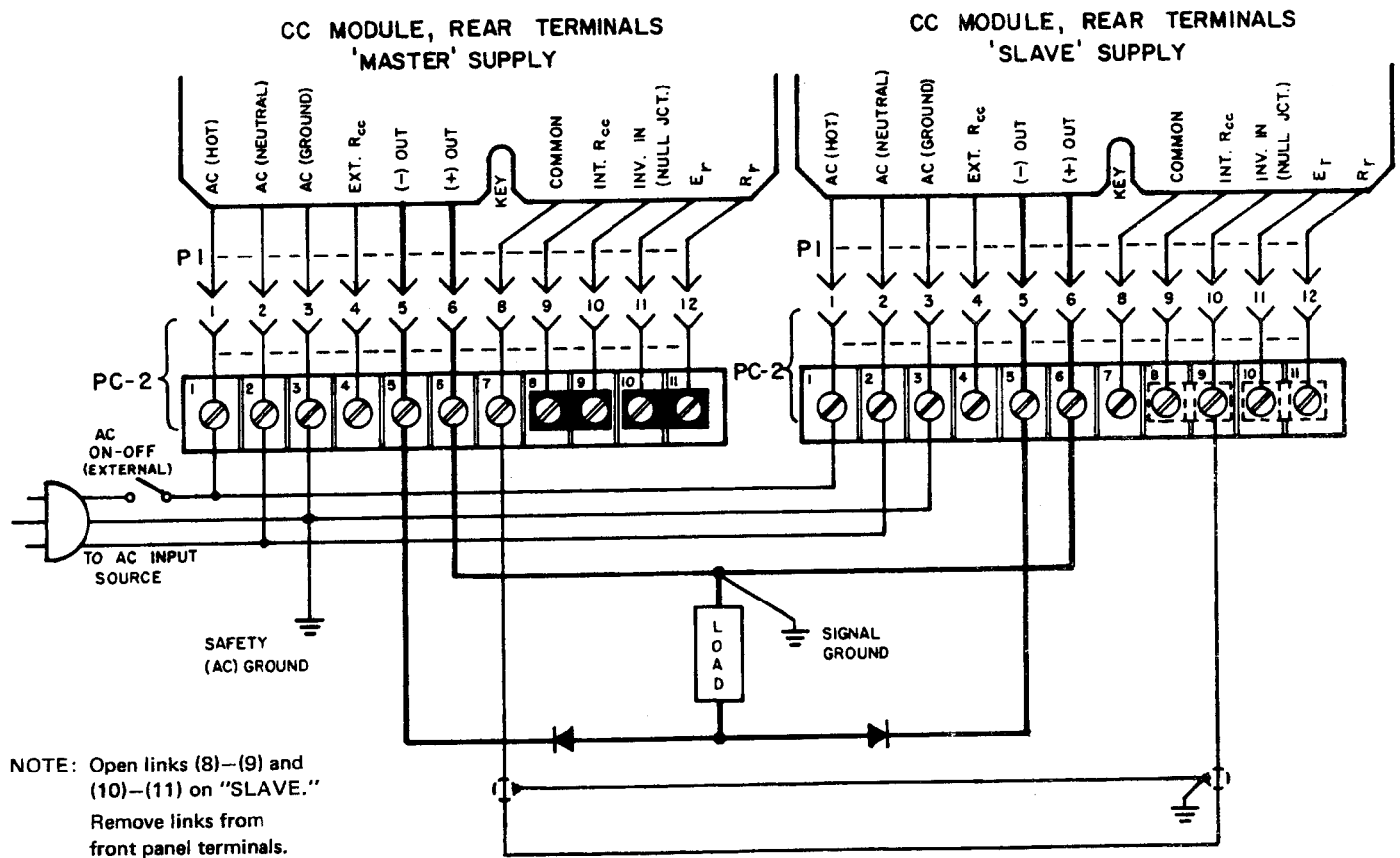

FIG. 3-11 "MASTER/SLAVE" PARALLEL CONNECTION.

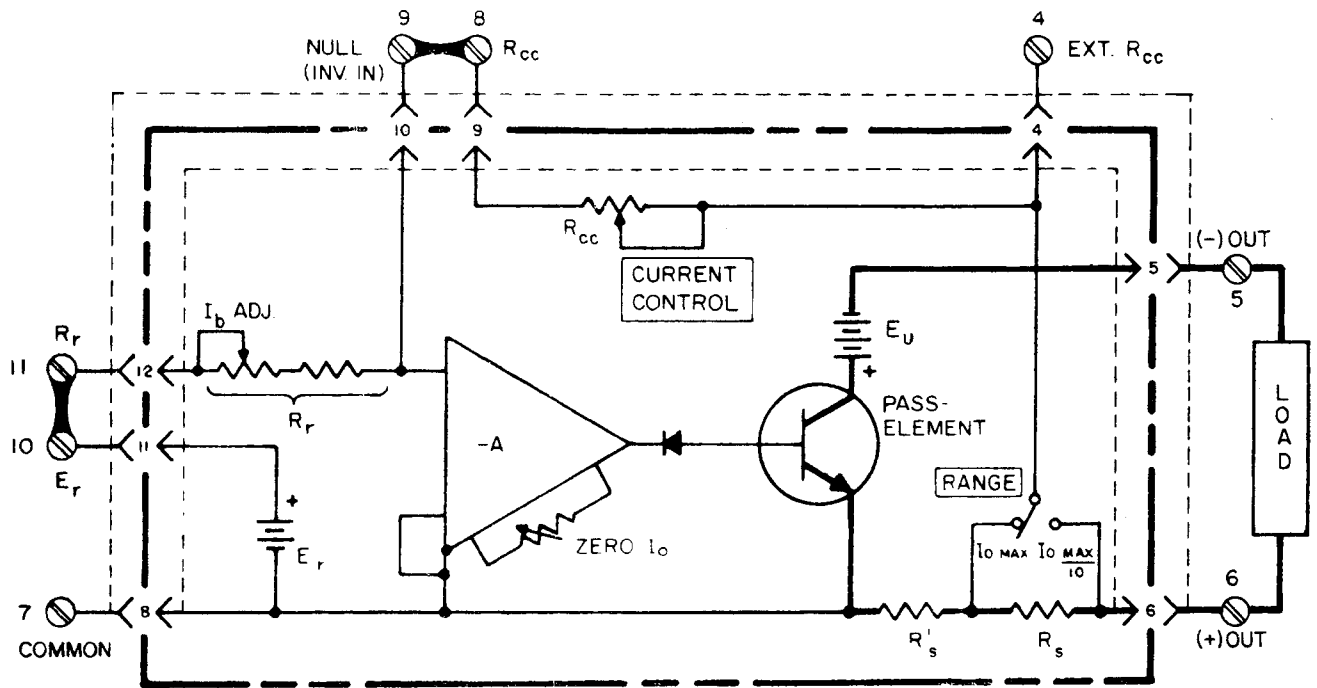

FIG. 3-12 SIMPLIFIED CONNECTION DIAGRAM, CC MODULE
(SHOWN WITH MODEL PC-2 PLUG-IN ADAPTOR)

- NOTES:** 1) THIS DIAGRAM MAY BE USED TO ANALYZE PROGRAMMING CIRCUITS. USE IN CONJUNCTION WITH BARRIER-STRIP DIAGRAMS IN SECTION III.
- 2) A-C INPUT TERMINALS *NOT* SHOWN, SEE BARRIER-STRIP DIAGRAM FOR COMPARISON.

